

6

5

4

3

2

1

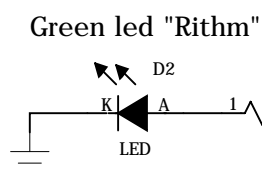
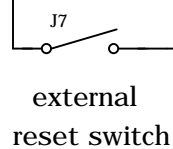
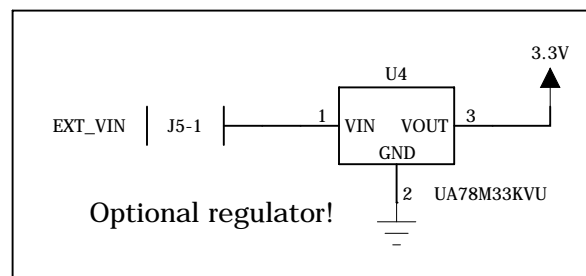

CD & WP pins grounded!

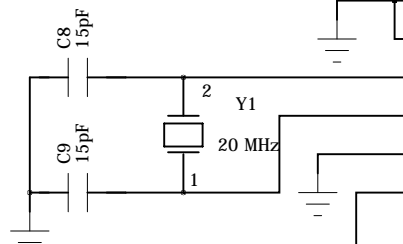

device = 8

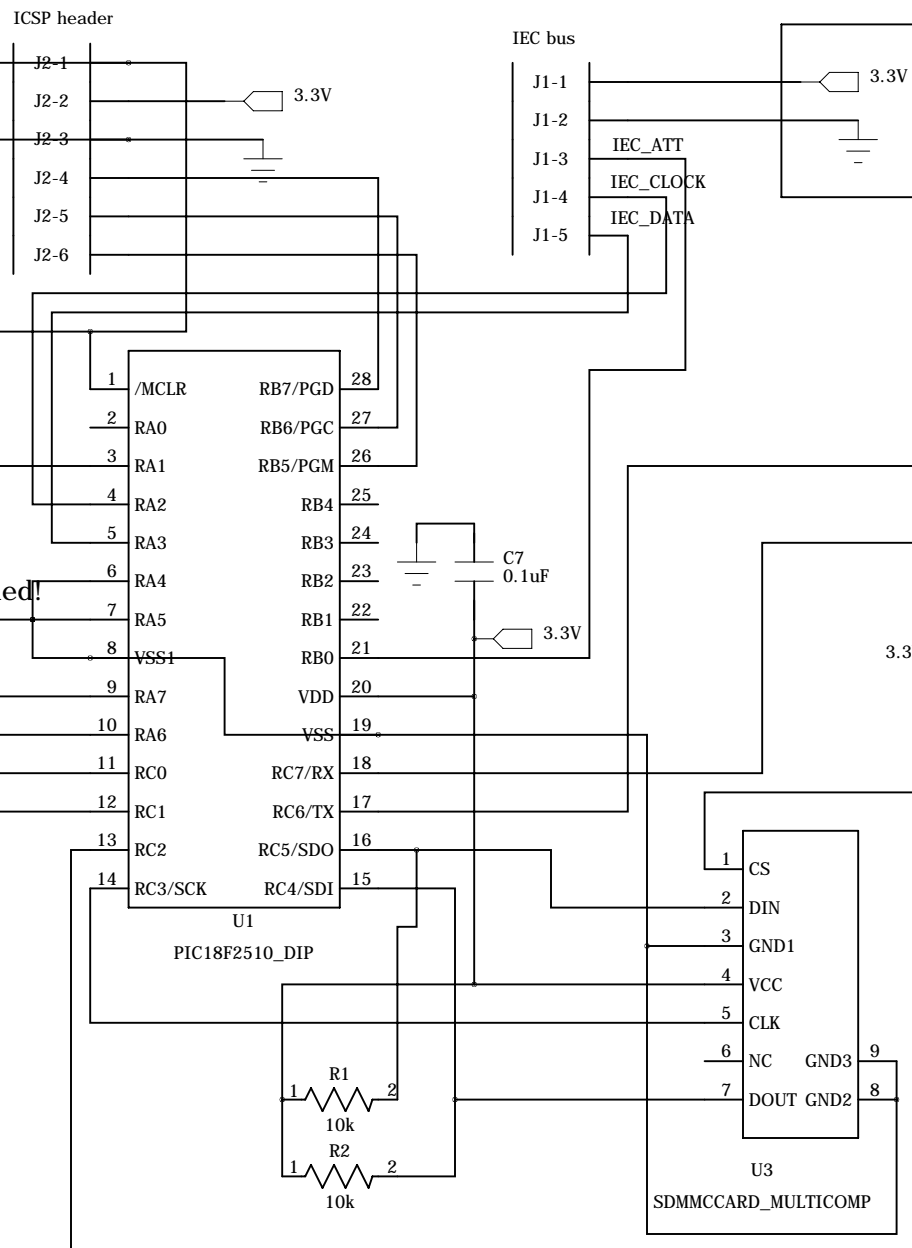
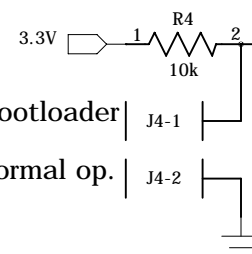

REVISION RECORD			
LTR	ECO NO:	APPROVED:	DATE:

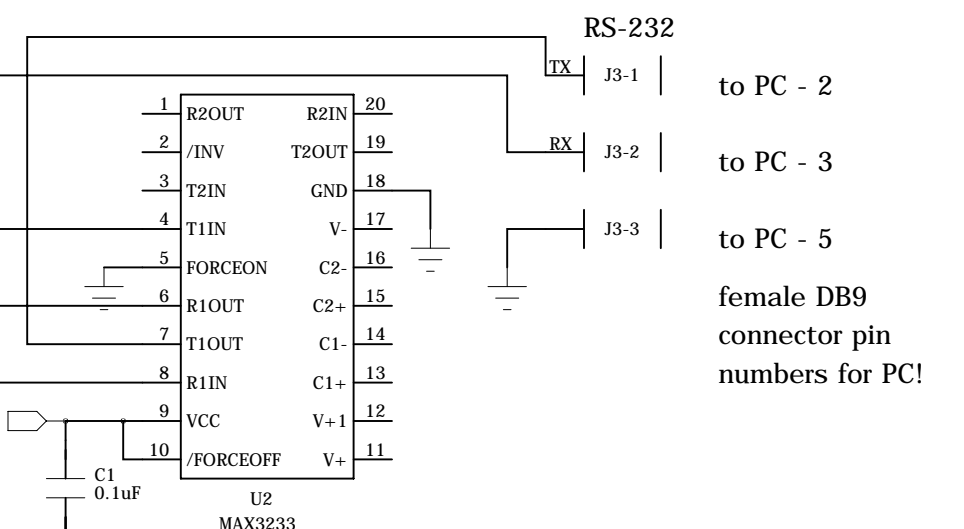

COMPANY: None

TITLE: DTV_1541-III_v11 (First released PCB version)

DRAWN: Jussi Säily	DATED: 15.07. 2006
CHECKED: J.S.	DATED: 15.07.2006
QUALITY CONTROL: J.S.	DATED: <QC Date>
RELEASED: J.S.	DATED: 01.10.2006

CODE: 1	SIZE: B	DRAWING NO: 1	REV: 1
SCALE: 1:1			SHEET: 1 of 1

D

D

C

C

B

B

A

A